

E. CARVER.  
 INSULATOR PIN OR BRACKET MACHINE.  
 APPLICATION FILED JUNE 20, 1910.

997,269.

Patented July 11, 1911.

3 SHEETS-SHEET 2.

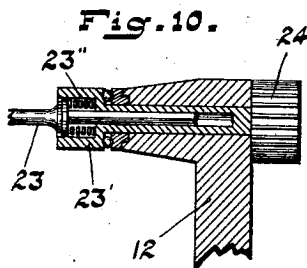
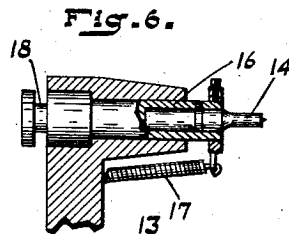
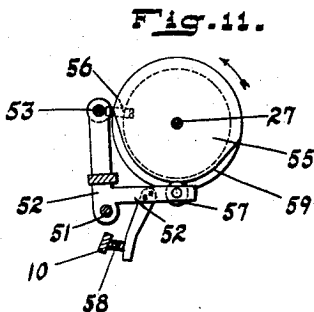
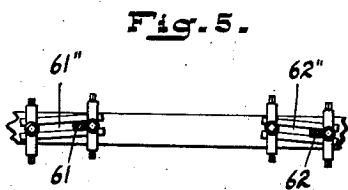
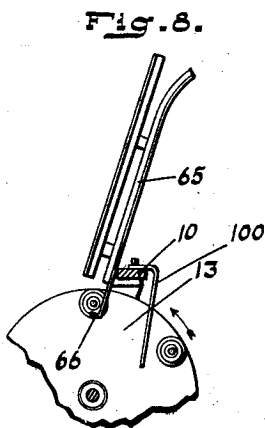
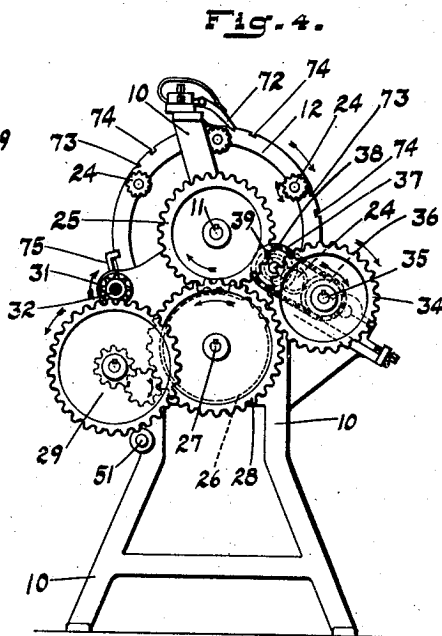
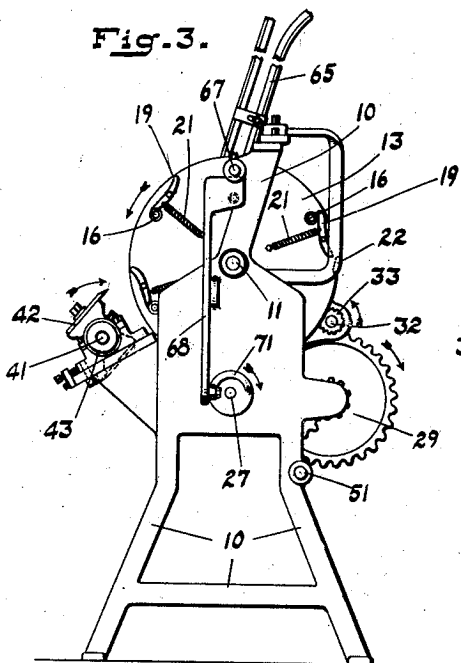

Witnesses  
 Walter Troemel.  
 Thomas W. McMeand

Inventor  
 Edwin Carver.

By *Bradford Hood*  
 Attorneys.